



MASTERBLOCK



Architectural Masonry Solutions



FOR OVER SIX DECADES WE HAVE SET THE STANDARD FOR INNOVATIVE CONCRETE MASONRY PRODUCTS ACROSS MINNESOTA AND THE DAKOTAS. WHETHER FOR STRUCTURAL OR VENEER APPLICATIONS, MASTERBLOCK ARCHITECTURAL CONCRETE MASONRY UNITS ARE PROVEN EXAMPLES OF THE FORM, FUNCTION AND ESTHETICS AVAILABLE TO TODAY'S DESIGNER.

INDEX

New	MasterBrick Structural and DuraBrick® Veneer Series	3-4
New	Stone Master Series	5-6
	Splyt Stone Quarry Series®	7-8
	Decorative Rock Face Series®	9-10
	Castle Rock & Shadow Stone Series®	11-12
	Groundstone Series®	13-14
	Soundblox®	15
	Enerblock®	16
	Color Options	17-20
	Ashlar Patterns for Splyt Stone Quarry Series	21-23
	Design Ideas	24
New	EnviroMaster Mix Design	25
	At your Service	26



ISO 14001 Certified Continuing to bring you quality and environmental excellence, MASTERBLOCK is proud to be the first concrete products company in the upper midwest to become certified.



Splyt Stone Quarry® Series

Create the appeal of a natural stone ashlar pattern on your next project. Choose one of our featured color blends or combine any of the colors in our Rock Face Series to create a signature look to your design.





Splyt Stone Quarry Series Features

- 13 standard stone-like shapes to select from allows for maximum design creativity.
- Sizes can be used individually or combined into striking ashlar patterns.
- Face/end corners and sill/accent piece options.
- Choose from 21 solid colors, 5 variegated color blends, or create your own signature blend.
- CO₂ curing ensures a completely hydrated fully cured "pre-shrunk" unit. CO₂ curing provides units that are consistent in color and have a greatly reduced efflorescence potential compared to conventionally cured units.

Splyt Stone Shapes Also shown in our Concrete Masonry Product Guide.

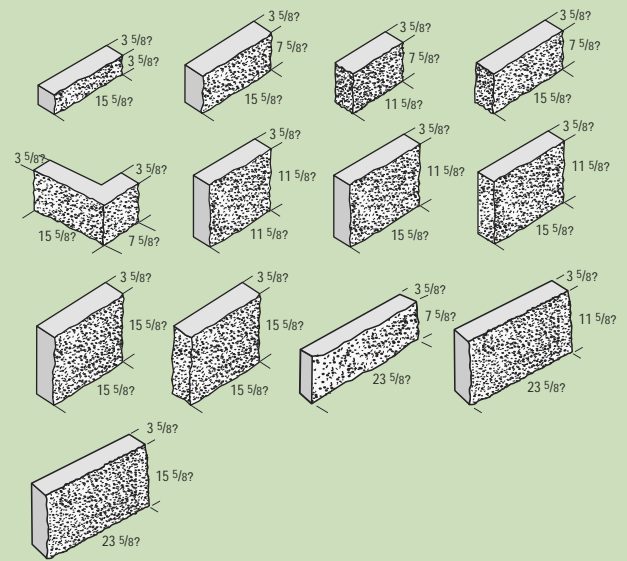

- Available in the new EnviroMaster Mix Design. (See page 25).

Splyt Stone Quarry Series® Color Options

(Also available in StoneMaster Series® and Decorative Rockface Series®)



Weathered Mankato
(Premier Series)



Mankato Pink
(Premier Series)



Autumn Prairie
(Custom Series)



Glacial Ridge
(Premier Series)



York Stone
(Premier Series)

Decorative Rock Face Series® Fergus Falls Color Options



Natural Gray
(Standard Series)



Ashlar Gray
(Custom Series)



Gray Balsam
(Custom Series)



Goldstone
(Custom Series)



Mesa Tan
(Custom Series)



Saddle Tan
(Custom Series)

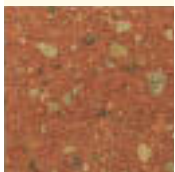

Terra Cotta
(Custom Series)



Brickstone
(Custom Series)



Burgandy
(Custom Series)



Barkwood
(Custom Series)



Mahogany
(Premier Series)



Ebony Rose
(Premier Series)

Colors shown above may vary slightly from actual products. Contact your local representative for current samples.

Decorative Rock Face Series® Elk River Color Options

(Also available in StoneMaster Series® and Splyt Stone Quarry Series®)



Natural Gray
(Standard Series)



Weathered Yorkshire
(Custom Series)



Nordic Basalt
(Premier Series)



Artic Frost
(Premier Series)



Dover Cliffs
(Premier Series)



Ivory Seashell
(Custom Series)



Mesabi
(Custom Series)



Kasota Bluff
(Premier Series)



Colonial Parchment
(Custom Series)



Desert Sand
(Custom Series)

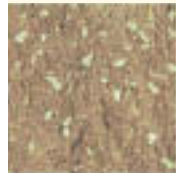

Cottonwood
(Custom Series)



Driftwood
(Custom Series)

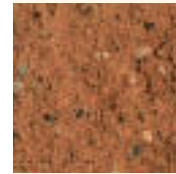

Sierra
(Custom Series)



Cotswold Stone
(Custom Series)



Weathered Dakota
(Custom Series)



Chestnut
(Custom Series)



North Shore
(Custom Series)



Burnt Hawthorne
(Custom Series)



Evening Rose
(Custom Series)



Autumn Rose
(Custom Series)



Georgia Clay
(Custom Series)

Colors shown above may vary slightly from actual products. Contact your local representative for current samples.

Ground Stone Colors® Color Options



Glacier Blend
(Standard Series)



St. Paul Limestone
(Standard Series)



Shakopee Limestone
(Standard Series)



Cottonwood
(Custom Series)



Sierra
(Custom Series)



Ivory Seashell
(Custom Series)



Desert Sand
(Custom Series)



Pipestone
(Custom Series)



Prairie Rose
(Custom Series)



Artic Sunset
(Custom Series)



Cotswold Stone
(Custom Series)



Kasota Bluff
(Premier Series)

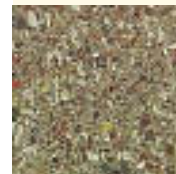

Kershaw
(Premier Series)

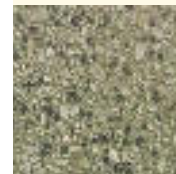

Brocade
(Premier Series)



Gray Quartz
(Premier Series)



Onyx Blush
(Premier Series)



Starry Night
(Premier Series)



Nordic Basalt
(Premier Series)

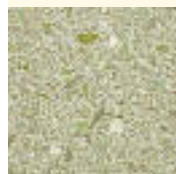

Artic Frost
(Premier Series)



Dover Cliffs
(Premier Series)

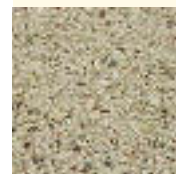

Kashmir White
(Premier Series)

Colors shown above may vary slightly from actual products. Contact your local representative for current samples.

Splyt Stone Quarry Series® Ashlar Patterns

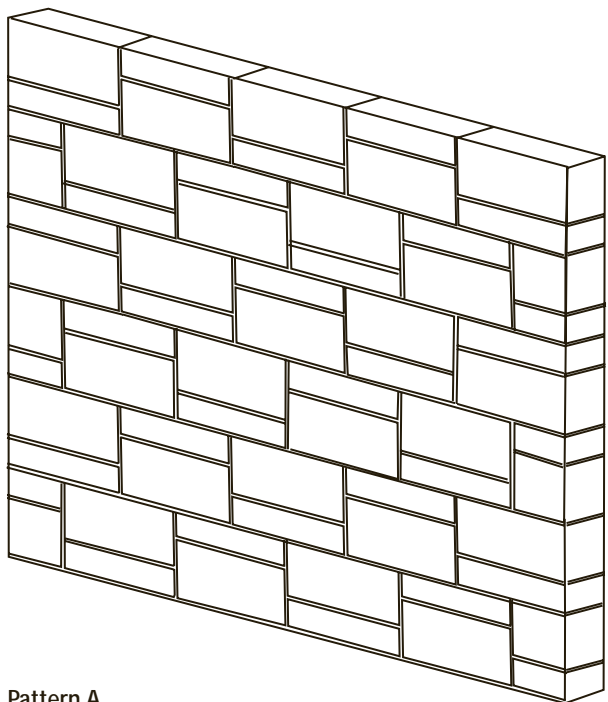

Pattern A

Unit Sizes:

$3\frac{5}{8} \times 3\frac{5}{8} \times 15\frac{5}{8}$

$3\frac{5}{8} \times 7\frac{5}{8} \times 15\frac{5}{8}$

This pattern can also be made using 6, 8, or 12 inch units in Decorative Rock Face, Split Stone or Ground Stone Series.

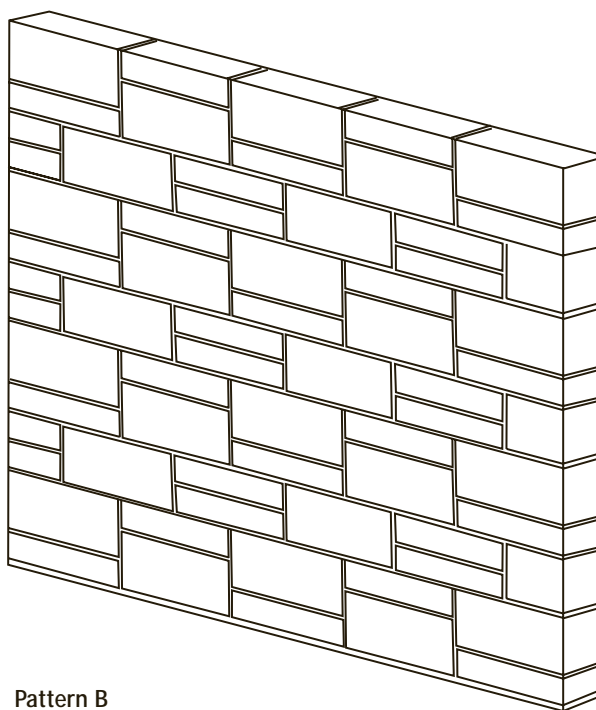

Pattern B

Unit Sizes:

$3\frac{5}{8} \times 3\frac{5}{8} \times 15\frac{5}{8}$

$3\frac{5}{8} \times 7\frac{5}{8} \times 15\frac{5}{8}$

This pattern can also be made using 6, 8, or 12 inch units in Decorative Rock Face, Split Stone or Ground Stone Series.

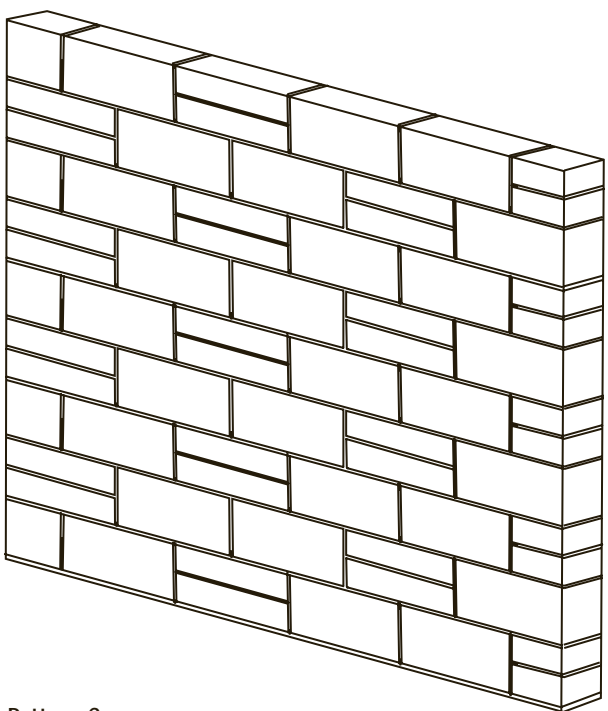

Pattern C

Unit Sizes:

$3\frac{5}{8} \times 3\frac{5}{8} \times 15\frac{5}{8}$

$3\frac{5}{8} \times 7\frac{5}{8} \times 15\frac{5}{8}$

This pattern can also be made using 6, 8, or 12 inch units in Decorative Rock Face, Split Stone or Ground Stone Series.

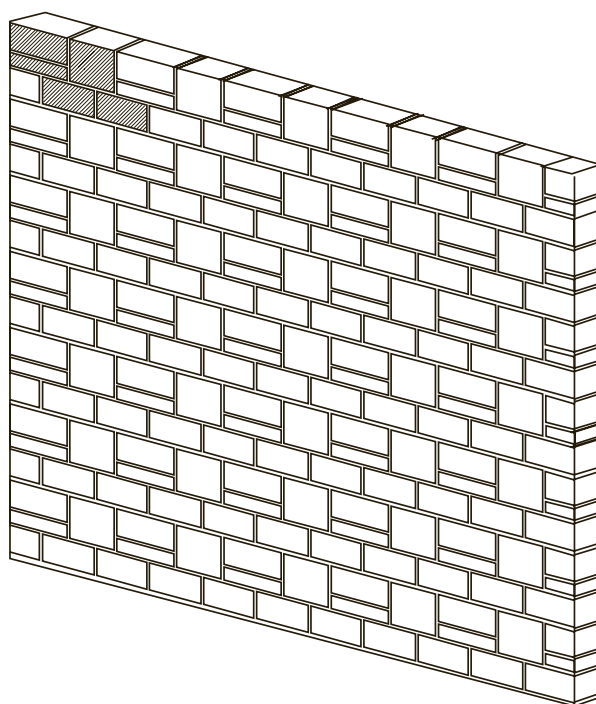

Pattern D

Unit Sizes:

$3\frac{5}{8} \times 3\frac{5}{8} \times 15\frac{5}{8}$

$3\frac{5}{8} \times 7\frac{5}{8} \times 15\frac{5}{8}$

$3\frac{5}{8} \times 11\frac{5}{8} \times 11\frac{5}{8}$

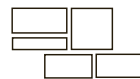

Patterns shown represent only a portion of possible combinations. Most patterns can be made using either Splyt Stone Quarry Series® or Groundstone Series® textures.

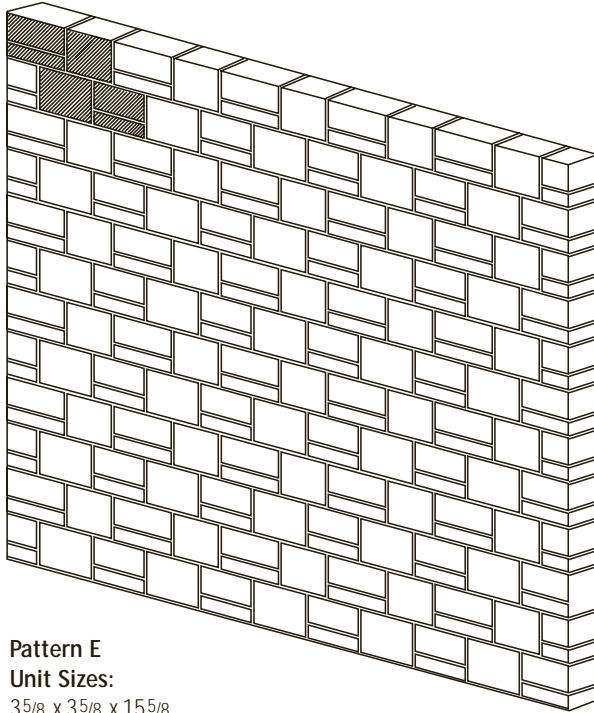

Pattern E

Unit Sizes:

- $3\frac{5}{8} \times 3\frac{5}{8} \times 15\frac{5}{8}$
- $3\frac{5}{8} \times 7\frac{5}{8} \times 15\frac{5}{8}$
- $3\frac{5}{8} \times 11\frac{5}{8} \times 11\frac{5}{8}$
- $3\frac{5}{8} \times 11\frac{5}{8} \times 15\frac{5}{8}$

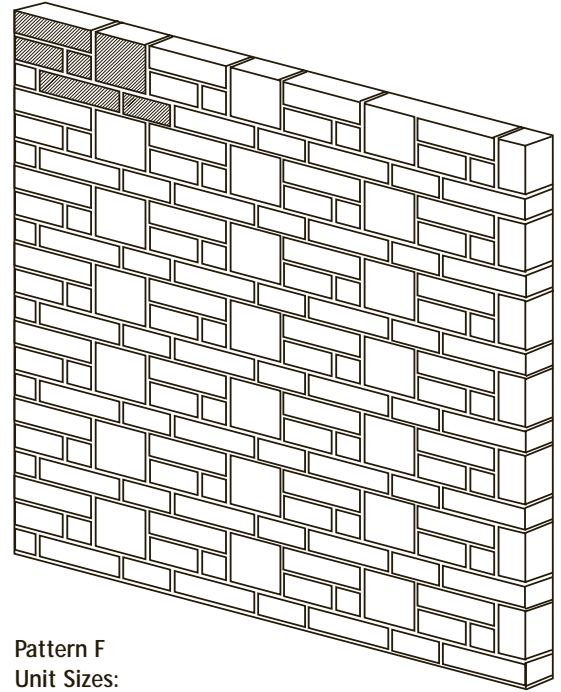
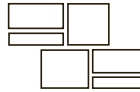

Pattern F

Unit Sizes:

- $3\frac{5}{8} \times 7\frac{5}{8} \times 7\frac{5}{8}$
- $3\frac{5}{8} \times 7\frac{5}{8} \times 15\frac{5}{8}$
- $3\frac{5}{8} \times 7\frac{5}{8} \times 23\frac{5}{8}$
- $3\frac{5}{8} \times 15\frac{5}{8} \times 15\frac{5}{8}$

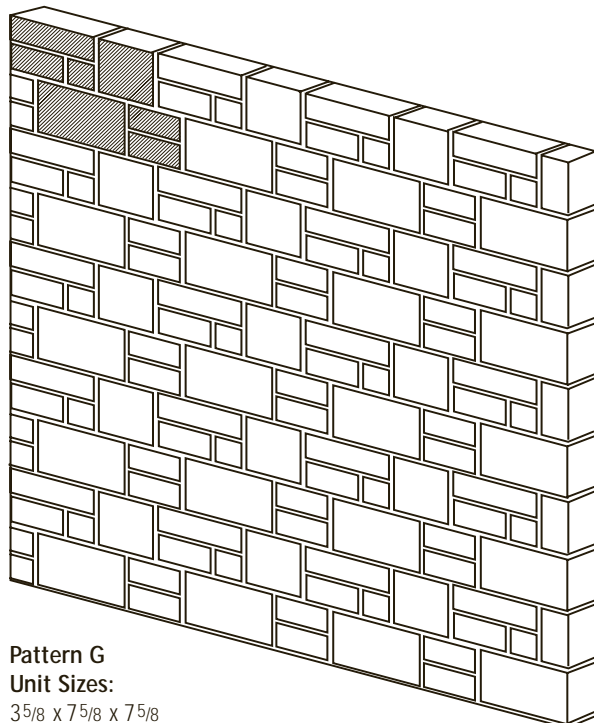
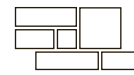

Pattern G

Unit Sizes:

- $3\frac{5}{8} \times 7\frac{5}{8} \times 7\frac{5}{8}$
- $3\frac{5}{8} \times 7\frac{5}{8} \times 15\frac{5}{8}$
- $3\frac{5}{8} \times 7\frac{5}{8} \times 23\frac{5}{8}$
- $3\frac{5}{8} \times 15\frac{5}{8} \times 15\frac{5}{8}$
- * $3\frac{5}{8} \times 15\frac{5}{8} \times 23\frac{5}{8}$

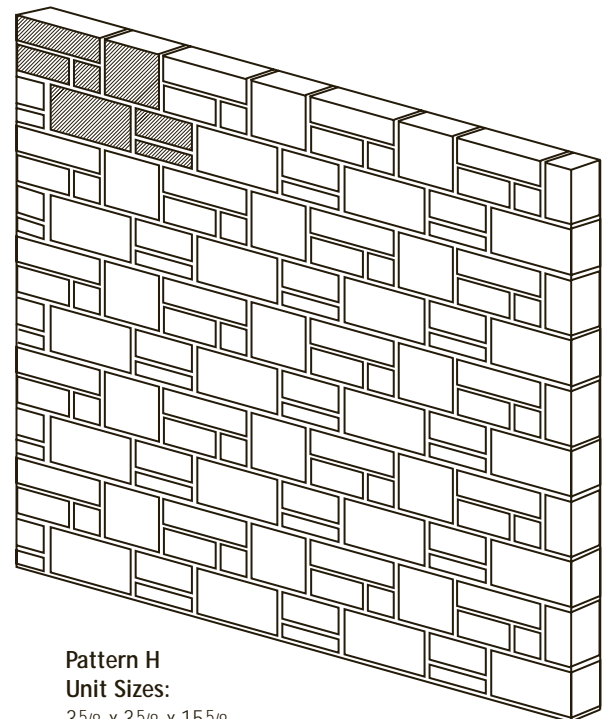
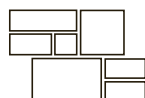

Pattern H

Unit Sizes:

- $3\frac{5}{8} \times 3\frac{5}{8} \times 15\frac{5}{8}$
- $3\frac{5}{8} \times 7\frac{5}{8} \times 7\frac{5}{8}$
- $3\frac{5}{8} \times 7\frac{5}{8} \times 15\frac{5}{8}$
- $3\frac{5}{8} \times 7\frac{5}{8} \times 23\frac{5}{8}$
- $3\frac{5}{8} \times 11\frac{5}{8} \times 23\frac{5}{8}$
- $3\frac{5}{8} \times 15\frac{5}{8} \times 15\frac{5}{8}$

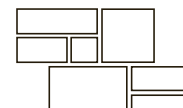

*This unit is only available in the Splyt Stone Quarry Series texture.

Splyt Stone Quarry Series® Ashlar Patterns

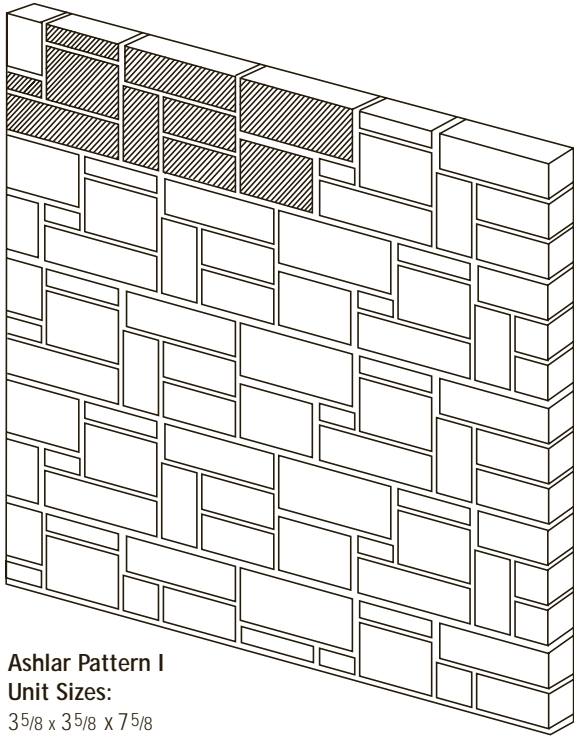

Ashlar Pattern I

Unit Sizes:

- 35/8 x 35/8 x 75/8
- 35/8 x 35/8 x 155/8
- 35/8 x 75/8 x 155/8
- 35/8 x 75/8 x 235/8
- 35/8 x 115/8 x 155/8
- 35/8 x 115/8 x 235/8

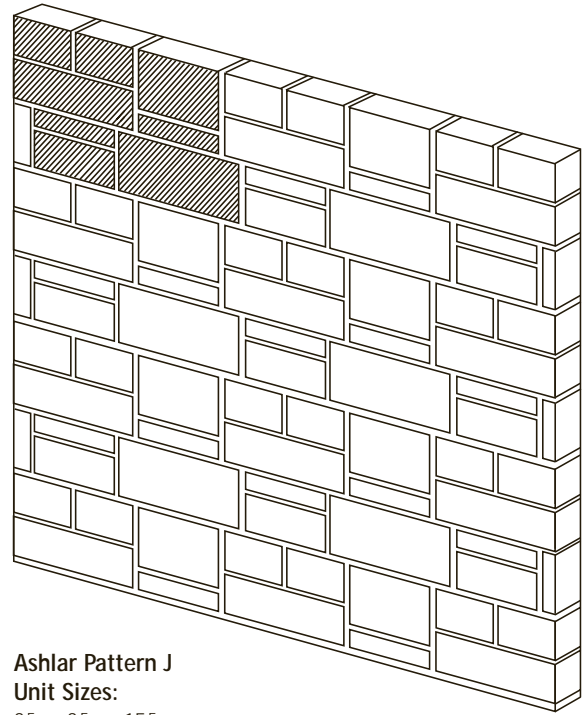
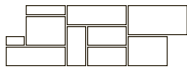

Ashlar Pattern J

Unit Sizes:

- 35/8 x 35/8 x 155/8
- 35/8 x 75/8 x 115/8
- 35/8 x 75/8 x 155/8
- 35/8 x 75/8 x 235/8
- 35/8 x 115/8 x 155/8
- 35/8 x 115/8 x 235/8

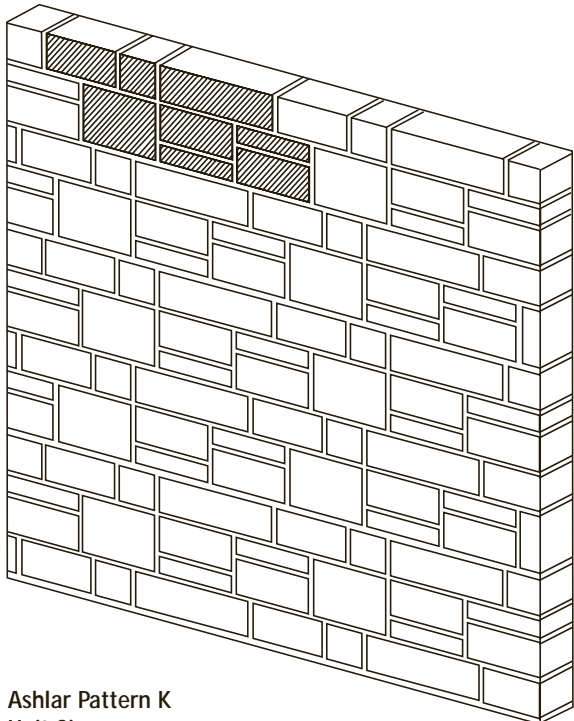
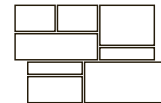

Ashlar Pattern K

Unit Sizes:

- 35/8 x 35/8 x 155/8
- 35/8 x 75/8 x 75/8
- 35/8 x 75/8 x 155/8
- 35/8 x 75/8 x 235/8
- 35/8 x 115/8 x 155/8

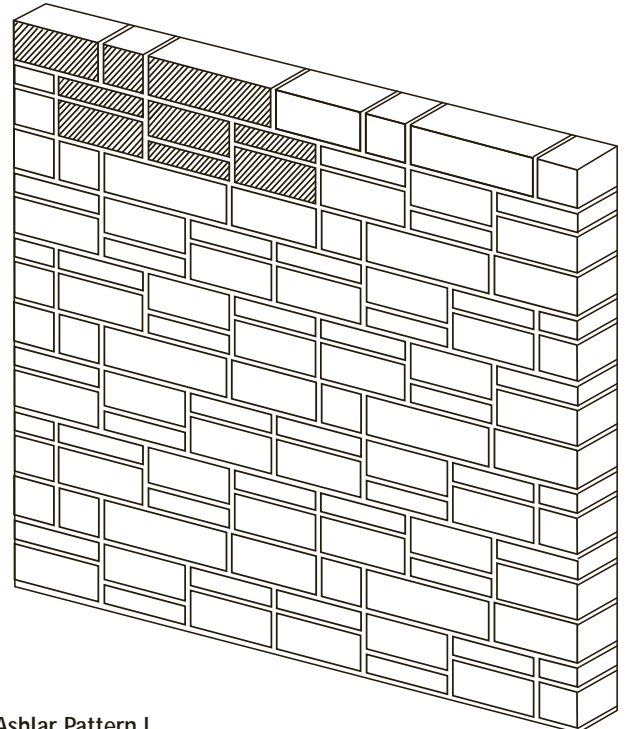

Ashlar Pattern L

Unit Sizes:

- 35/8 x 35/8 x 155/8
- 35/8 x 75/8 x 75/8
- 35/8 x 75/8 x 155/8
- 35/8 x 75/8 x 235/8



Design Ideas



EnviroMaster Mix Design Sustainability Built In

In response to the growing demand for sustainable construction products MasterBlock has created the EnviroMaster Mix Design.

MasterBlock is continually striving to bring you innovative new materials, improve our products and facilities and minimize their effect on the environment.

Perfect for sustainable design projects, (LEED, etc.) the EnviroMaster Mix Design utilizes approximately 40% post industrial waste material and meets or exceeds ASTM C90 standards for load bearing concrete masonry. The EnviroMaster Mix Design can be produced in most architectural sizes, shapes, and finishes, and is available in a range of attractive earthtone colors.

Contact your MasterBlock representative for more information regarding the EnviroMaster Mix Design, concrete masonry with sustainability built in.



MASTERBLOCK IS PROUD TO USE THE FOLLOWING QUALITY PRODUCTS AND TECHNOLOGY IN THE MANUFACTURE OF MANY OF THE ARCHITECTURAL CONCRETE PRODUCTS INCLUDED IN THIS LITERATURE.

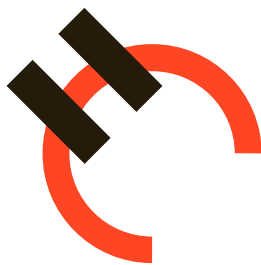

Holcim

Strength. Performance. Passion.



At your service

with innovative products and superior solutions.

MASTERBLOCK is committed to whatever it takes to help make your next project a success. Friendly, courteous, knowledgeable service is just a phone call away. Our services include:

- Technical assistance.
- Custom color matching for additions to existing projects.
- Custom cut samples for sample boards.
- Final and preliminary design services for Keystone Retaining Wall Systems. See our Landscape Product Guide for product selection.
- Custom color production of Keystone Retaining Walls to blend with our Architectural Concrete Masonry Units.
- Single source for all types of Concrete Masonry Segmental Retaining Walls, Pavers, Ready Mix and Aggregates.
- AIA/CES accredited box lunch programs, call today to schedule yours.

Visit MASTERBLOCK and Keystone Websites.

The MASTERBLOCK Website provides information for all Architectural Concrete Masonry, Keystone and paver products.

The Keystone Website is a one-step source for your Keystone product information — including individual portals for designers and contractors, plus information about our unique retaining wall design software.

MASTERBLOCK Website: www.masterblock-us.com

KEYSTONE Website: www.Keystonewalls.com



MASTERBLOCK SUPPORTS AND IS A PROUD MEMBER OF THE FOLLOWING ASSOCIATIONS.



2915 Waters Road
Suite 105
Eagan, MN 55121

Twin Cities: 651-683-0600
Twin Cities: 1-800-338-0016
Fax: 651-686-6969
Fergus Falls: 1-800-426-8162
Fergus Falls Fax: 218-739-5779
www.masterblock-us.com